

KENWOOD

MINIDISC RECORDER

DM-B9

INSTRUCTION MANUAL

KENWOOD CORPORATION

For your records

Record the serial number, found on the back of the unit, in the spaces designated on the warranty card, and in the space provided below. Refer to the model and serial numbers whenever you call upon your dealer for information or service on this product.

Model _____ Serial Number _____



Before applying power

Caution: Read this page carefully to ensure safe operation.

2 Unpacking

Unpack the unit carefully and make sure that all accessories are put aside so they will not be lost. Examine the unit for any possibility of shipping damage. If your unit is damaged or fails to operate, notify your dealer immediately. If your unit was shipped to you directly, notify the shipping company without delay. Only the consignee (the person or company receiving the unit) can file a claim against the carrier for shipping damage. We recommend that you retain the original carton and packing materials for use should you transport or ship the unit in the future.

Before applying power

Units are designed for operation as follows.

U.S.A. and Canada 120 V only
U.K. and Australia 240 V only

Europe (Except for U.K.) 230 V only
Other countries 110-120 / 220-240 V switch

For the United Kingdom

Factory fitted moulded mains plug

1. The mains plug contains a fuse. For replacement, use only a 13-Amp ASTA-approved (BS1362) fuse.
2. The fuse cover must be refitted when replacing the fuse in the moulded plug.
3. Do not cut off the mains plug from this equipment. If the plug fitted is not suitable for the power points in your home or the cable is too short to reach a power point, then obtain an appropriate safety approved extension lead or adapter, or consult your dealer.
If nonetheless the mains plug is cut off, remove the fuse and dispose of the plug immediately, to avoid a possible shock hazard by inadvertent connection to the mains supply.

AC voltage selection

This unit operates on 110 - 120 volts or 220 - 240 volts AC. The AC voltage selector switch Type A or Type B on the rear panel is set to the voltage that prevails in the area to which the unit is shipped. Before connecting the power cord to your AC outlet, make sure that the setting position of this switch matches your line voltage. If not, it must be set to your voltage in accordance with the following direction.

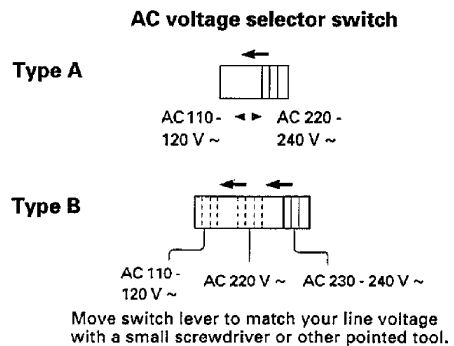

Note:
Our warranty does not cover damage caused by excessive line voltage due to improper setting of the AC voltage selector switch.

Safety precautions

WARNING: TO PREVENT FIRE OR ELECTRIC SHOCK, DO NOT EXPOSE THIS APPLIANCE TO RAIN OR MOISTURE.



CAUTION
RISK OF ELECTRIC SHOCK
DO NOT OPEN



CAUTION: TO REDUCE THE RISK OF ELECTRIC SHOCK, DO NOT REMOVE COVER (OR BACK). NO USER-SERVICEABLE PARTS INSIDE, REFER SERVICING TO QUALIFIED SERVICE PERSONNEL.



THE LIGHTNING FLASH WITH ARROWHEAD SYMBOL, WITHIN AN EQUILATERAL TRIANGLE, IS INTENDED TO ALERT THE USER TO THE PRESENCE OF UNINSULATED "DANGEROUS VOLTAGE" WITHIN THE PRODUCT'S ENCLOSURE THAT MAY BE OF SUFFICIENT MAGNITUDE TO CONSTITUTE A RISK OF ELECTRIC SHOCK TO PERSONS.



THE EXCLAMATION POINT WITHIN AN EQUILATERAL TRIANGLE IS INTENDED TO ALERT THE USER TO THE PRESENCE OF IMPORTANT OPERATING AND MAINTENANCE (SERVICING) INSTRUCTIONS IN THE LITERATURE ACCOMPANYING THE APPLIANCE.

Contents

Caution : Read the pages marked **!** carefully to ensure safe operation.

Before applying power	Unpacking	2
	△ Before applying power	2
	△ Safety precautions	2
	△ IMPORTANT SAFEGUARDS	4
	Before operation	6
Special feature	7
System connections	8
	Connection of system control cords (Connected to UD-901 or UD-951M)	9
Controls and indicators	10
Operation of remote control unit	13
Playback of Mini Disc	14
	Playing tracks in order from track No. 1	14
	Playback from desired track	15
	Programming tracks in desired order	16
	Repeated playback	18
Recording (analog input)	20
Recording (digital input)	22
Editing	24
	Inserting track numbers	24
	Canceling track numbers	25
	Deleting a track	26
Title assignment	28
	Assigning a title to disc	28
	Assigning a title to track	29
	Changing a title	30
	Deleting a title	31
Timer operations	32
	Timer playback	32
	Timer recording of radio	33
	34
Maintenance	35
MD system	35
In case of difficulty	36
Specifications	38

IMPORTANT SAFEGUARDS

⚠ Caution : Read this page carefully to ensure safe operation.

Please read all of the safety and operating instructions before operating this appliance. Adhere to all warnings on the appliance and in the instruction manual. Follow all the safety and operating instructions. These safety and operating instructions should be retained for future reference.

- 1. Power sources** – The appliance should be connected to a power supply only of the type described in the instruction manual or as marked on the appliance. If you are not sure of the type of power supply to your home, consult your appliance dealer or local power company. For appliances intended to operate from battery power, or other sources, refer to the instruction manual.
- 2. Power-cord protection** – Power-supply cords should be routed so that they are not likely to be walked on or pinched by items placed upon or against them, pay particular attention to cords at plugs, convenience receptacles, and the point where they exit from the appliance.

Never pull or stretch the cord.

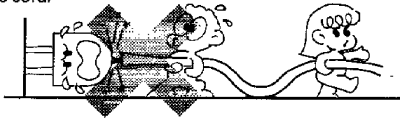

- 3. CAUTION – Polarization** – This appliance may be equipped with a polarized alternating-current line plug (a plug having one blade wider than the other). This plug will fit into the power outlet only one way. This is a safety feature. If you are unable to insert the plug fully into the outlet, try reversing the plug. If the plug should still fail to fit, contact your electrician to replace your obsolete outlet. Do not defeat the safety purpose of the polarized plug.
- 4. Ventilation** – Slots and openings in the cabinet are provided for ventilation and to ensure reliable operation of the appliance and to protect it from overheating, and these openings must not be blocked or covered. The appliance should be situated so that its location or position does not interfere with its proper ventilation.
To maintain good ventilation, do not put records or a table-cloth on the appliance. Place the appliance at least 10 cm away from the walls.
Do not use the appliance on a bed, sofa, rug or similar surface that may block the ventilation openings. This appliance should not be placed in a built-in installation such as a bookcase or rack unless proper ventilation is provided or the manufacturer's instructions have been adhered to.

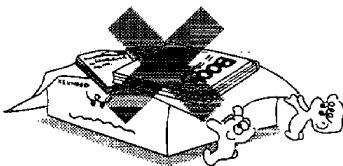

- 5. Water and moisture** – The appliance should not be used near water - for example, near a bathtub, washbowl, kitchen sink, laundry tub, in a wet basement, or near a swimming pool, etc.

- 6. Temperature** – The appliance may not function properly if used at extremely low, or freezing temperatures. The ideal ambient temperature is above +5°C (41°F).
- 7. Heat** – The appliance should be situated away from heat sources such as radiators, heat registers, stoves, or other appliances (including amplifiers) that produce heat.
- 8. Electric shock** – Care should be taken so that objects do not fall and liquid is not spilled into the enclosure through openings. If a metal object, such as a hair pin or a needle, comes into contact with the inside of this appliance, a dangerous electric shock may result. For families with children, never permit children to put anything, especially metal, inside this appliance.

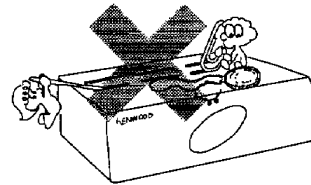

- 9. Enclosure removal** – Never remove the enclosure. If the internal parts are touched accidentally, a serious electric shock might occur.

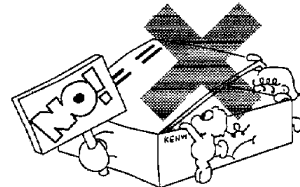

- 10. Magnetic fields** – Keep the appliance away from sources of magnetic fields such as TV sets, speaker systems, radios, motorized toys or magnetized objects.
- 11. Cleaning** – Unplug this appliance from the wall outlet before cleaning. Do not use volatile solvents such as alcohol, paint thinner, gasoline, or benzine, etc. to clean the cabinet. Use a clean dry cloth.
- 12. Accessories** – Do not place this appliance on an unstable cart, stand, tripod, bracket, or table. The appliance may fall, causing serious injury to a child or adult, and serious damage to the appliance. Use only with a cart, stand, tripod, bracket, or table recommended by the manufacturer, or sold with the appliance. Any mounting of the appliance should follow the manufacturer's instructions, and should use a mounting accessory recommended by the manufacturer. An appliance and cart combination should be moved with care. Quick stops, excessive force, and uneven surfaces may cause the appliance and cart combination to overturn.



Caution : Read this page carefully to ensure safe operation.

13. Lightning – For added protection for this appliance during a lightning storm, or when it is left unattended and unused for long periods of time, unplug it from the wall outlet and disconnect the antenna or cable system. This will prevent damage to the appliance due to lightning and power-line surges.

14. Abnormal smell – If an abnormal smell or smoke is detected, immediately turn the power OFF and unplug the appliance from the wall outlet. Contact your dealer or nearest service center.

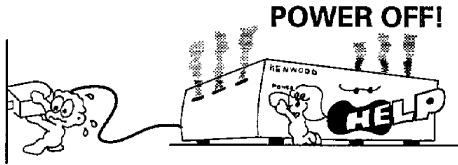

15. Damage requiring service – The appliance should be serviced by qualified service personnel when:

- A.** The power-supply cord or the plug has been damaged.
- B.** Objects have fallen, or liquid has been spilled into the appliance.
- C.** The appliance has been exposed to rain or water.
- D.** The appliance does not appear to operate normally by following the instruction manual. Adjust only those controls that are covered by the instruction manual as an improper adjustment of other controls may result in damage and will often require extensive work by a qualified technician to restore the appliance to its normal operation.
- E.** The appliance has been dropped, or the enclosure damaged.
- F.** The appliance exhibits a marked change in performance.

16. Servicing – The user should not attempt to service the appliance beyond that described in the instruction manual. All other servicing should be referred to qualified service personnel.

17. Outdoor antenna grounding – If an outside antenna is connected to the appliance, be sure the antenna system is grounded so as to provide some protection against voltage surges and built up static charges. Article 810 of the National Electrical Code. ANSI/NFPA 70, provides information with respect to proper grounding of the mast and supporting structure, grounding of the lead-in wire to an antenna discharge unit, size of grounding conductors, location of antenna discharge unit, connection to grounding electrodes, and requirements for the grounding electrode. See Figure.

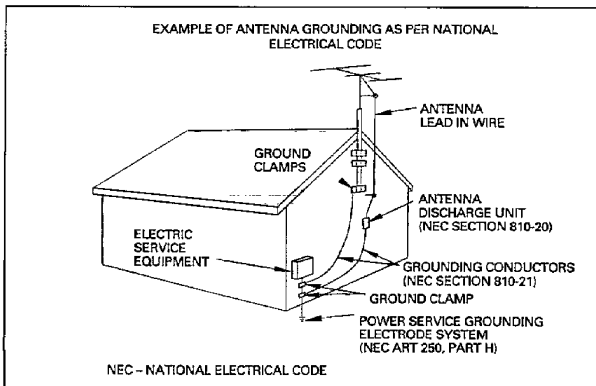

18. Power lines – An outside antenna system should not be located in the vicinity of overhead power lines or other electric light or power circuits, or where it can fall into such power lines or circuits. When installing an outside antenna system, extreme care should be taken to keep from touching such power lines or circuits as contact with them might be fatal.

19. AC outlets – Do not connect other audio equipment with a power consumption larger than that specified to the AC outlet on the rear panel. Never connect other electrical appliances, such as an iron or toaster, to it to prevent fire or electric shock.

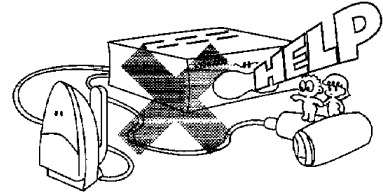

20. Overloading – Do not overload wall outlets, extension cords, or integral convenience receptacles as this can result in a risk of fire or electric shock.

21. Attachment – Do not use attachments not recommended by the appliance manufacturer as they may cause hazards.

22. Replacement parts – When replacement parts are required, be sure the service technician has used replacement parts specified by the manufacturer or have the same characteristics as the original parts. Unauthorized substitutions may result in fire, electric shock, or other hazards.

23. Safety check – Upon completion of any service or repairs to this appliance, ask the service technician to perform safety checks to determine that the appliance is in proper operating condition.

Notes:

- 1. Item 3 is not required except for grounded or polarized equipment.
- 2. Item 17 and 18 are not required except for units provided with antenna terminals.
- 3. Item 17 complies with UL in the U.S.A.

Before operation

6

Accessories

Audio cords (2)

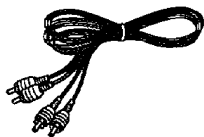

System control cord (1)

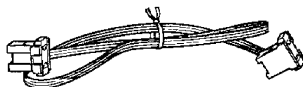

Optical fiber cable (1)

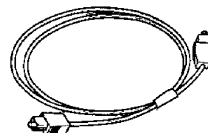

Remote control unit (1)

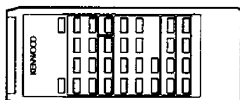

Batteries (R03/AAA) (2)



Except for U.S.A., Canada, U.K.,
Europe and Australia

AC plug adapter (1)

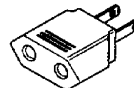

For use with the unit with an Euro-
pean AC plug in areas other than Eu-
rope.

For the U.S.A.

CAUTION:

Use of controls or adjustments or performance of procedures other than those specified herein may result in hazardous radiation exposure.

In compliance with Federal Regulations, following are reproductions of labels on, or inside the product relating to laser product safety.

KENWOOD CORPORATION
SHIONOGI SHIBUYA BUILDING 17-5,
2-CHOME, SHIBUYA SHIBUYA-KU,
TOKYO, JAPAN

KENWOOD CORP. CERTIFIES THIS EQUIPMENT CON-
FORMS TO DHHS REGULATIONS NO.21
CFR 1040. 10, CHAPTER I, SUBCHAPTER J.

Location: Back Panel

The marking of products using lasers (Except for some areas)

**CLASS 1
LASER PRODUCT**

This label is attached to the rear panel and says that the compo-
nent uses laser beams that have been classified as Class 1. It
means that the unit is utilizing laser beams that are of a weaker
class. There is no danger of hazardous radiation outside the unit.

WARNING NOTICE:

IN MOST CASES IT IS AN INFRINGEMENT OF COPYRIGHT TO
MAKE COPIES OF TAPES OR DISCS WITHOUT THE PERMISSION
OF THE COPYRIGHT OWNERS. ANYONE WISHING TO COPY
COMMERCIALY AVAILABLE TAPES OR DISCS SHOULD CON-
TACT THE MECHANICAL COPYRIGHT PROTECTION SOCIETY
LIMITED OR THE PERFORMING RIGHTS SOCIETY LIMITED.

Special feature

This unit is audio equipment based on the Mini Disc format. The Mini Disc (MD) applies optical and photomagnetic technologies to record audio in a disc just like with the conventional Compact Cassette. The MD has an equivalent operability to the Compact Disc (CD). The MD recording is not altered by external factors and the disc is not damaged by playback because an optical, non-contact readout system is used.

Convenient playback features

Various playback features are available as simply as the CD. Select the feature you like according to the purposes.

- Playback from the beginning
- Playback from the desired track
- Playback of desired tracks only
- Repeated playback

High-quality recording

This unit is capable of recording audio on recordable Mini Discs. It can record digital inputs with high audio quality as well as analog inputs.

This unit reproduces high audio quality from an information amount of about 1/5 compared to CD by utilizing the efficient encoding technology which cuts components inaudible to human ears based on the psychoacoustics. The maximum recording time is 74 minutes.

Convenient editing features

The contents of the disc recorded by yourself can be edited as you need.

- Inserting track numbers: Track numbers can be inserted in desired positions.
- Deleting track numbers: A piece of music which has been separated into 2 tracks can be unified.
- Deleting music track: Music tracks you do not want to listen to can be deleted.

Title assignment

Titles can be given to a recorded disc or tracks recorded in it.

Timer operation

By connecting this unit to the UD-901, UD-951M system through a system control cord, playback and recording can be activated at the desired time of day. Playback or recording can also be activated at the desired time by using a commercially available timer.

System connections

8

Make connection as shown below. When connecting the related system components, refer also to the instruction manuals of the related components.

Do not plug in the power lead until all connections are completed.

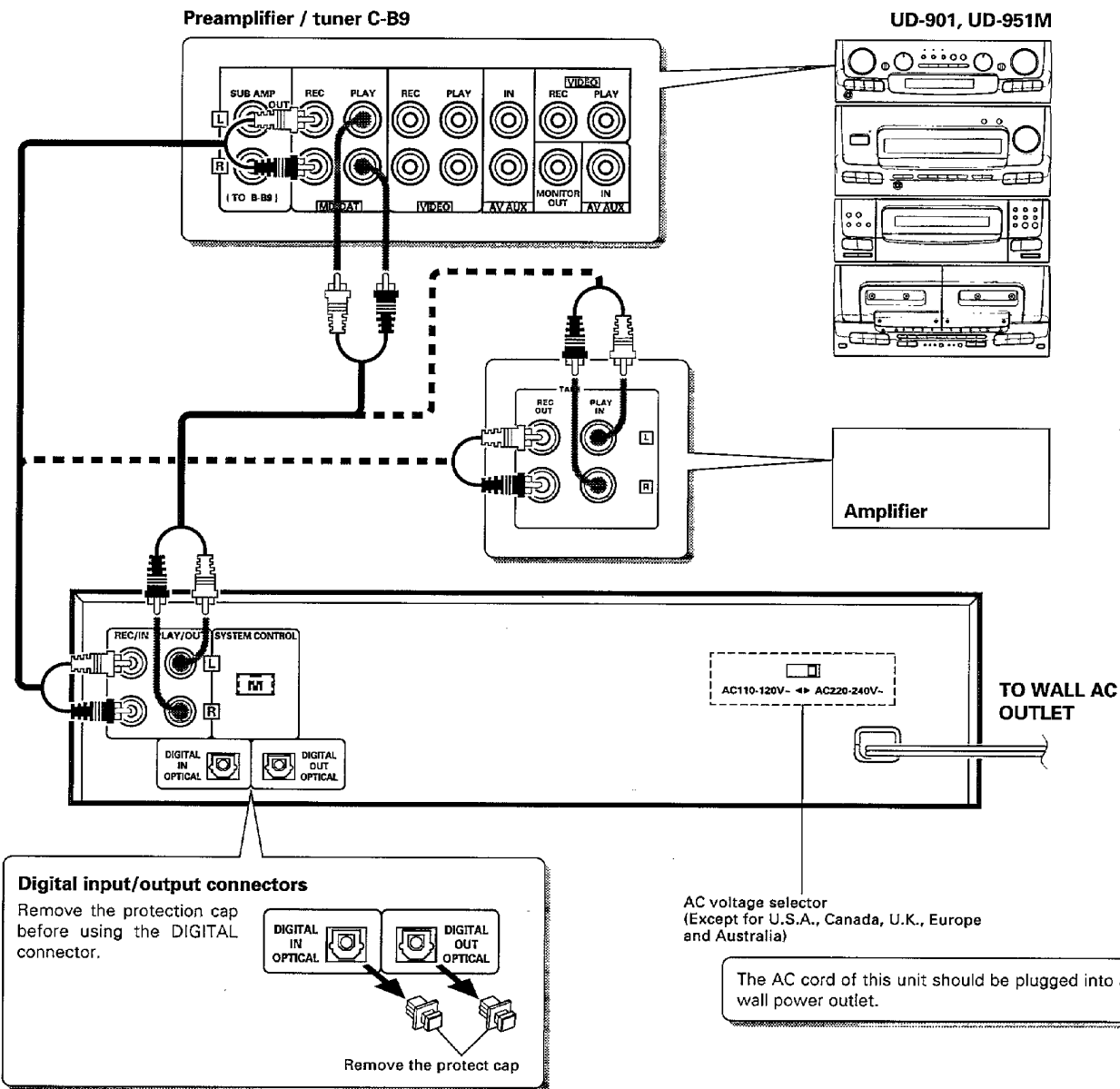

Note on connection of optical-fiber cable

This cable is for use in connection with the DP-MB9 CD player (optional). The digital signal transmission through the cable allows recording without spoiling the high sound quality of CD. A connection to an amplifier equipped with the digital input connector (for optical fiber) is also possible.

- Insert the optical-fiber cable straight into the connector until it clicks.
- Be sure to attach the protection cap when the connector is not used.
- Never bend or bundle the optical-fiber cable.
- All of the optical-fiber cables sold in audio stores cannot always be used. If the cable you purchased cannot be connected to this unit, please consult your dealer or KENWOOD distributor.

Notes

1. Connect all cords firmly. If connections are loose, there could be loss of sound or noise produced.
2. When plugging and unplugging connection cords, be sure to first remove the power cord from the AC outlet. Plugging/unplugging connection cords without removal of the power cord can cause malfunctions or damage to the unit.

Connection of system control cords (Connected to UD-901 or UD-951M)

Connect the system control cords as shown in the diagram below.

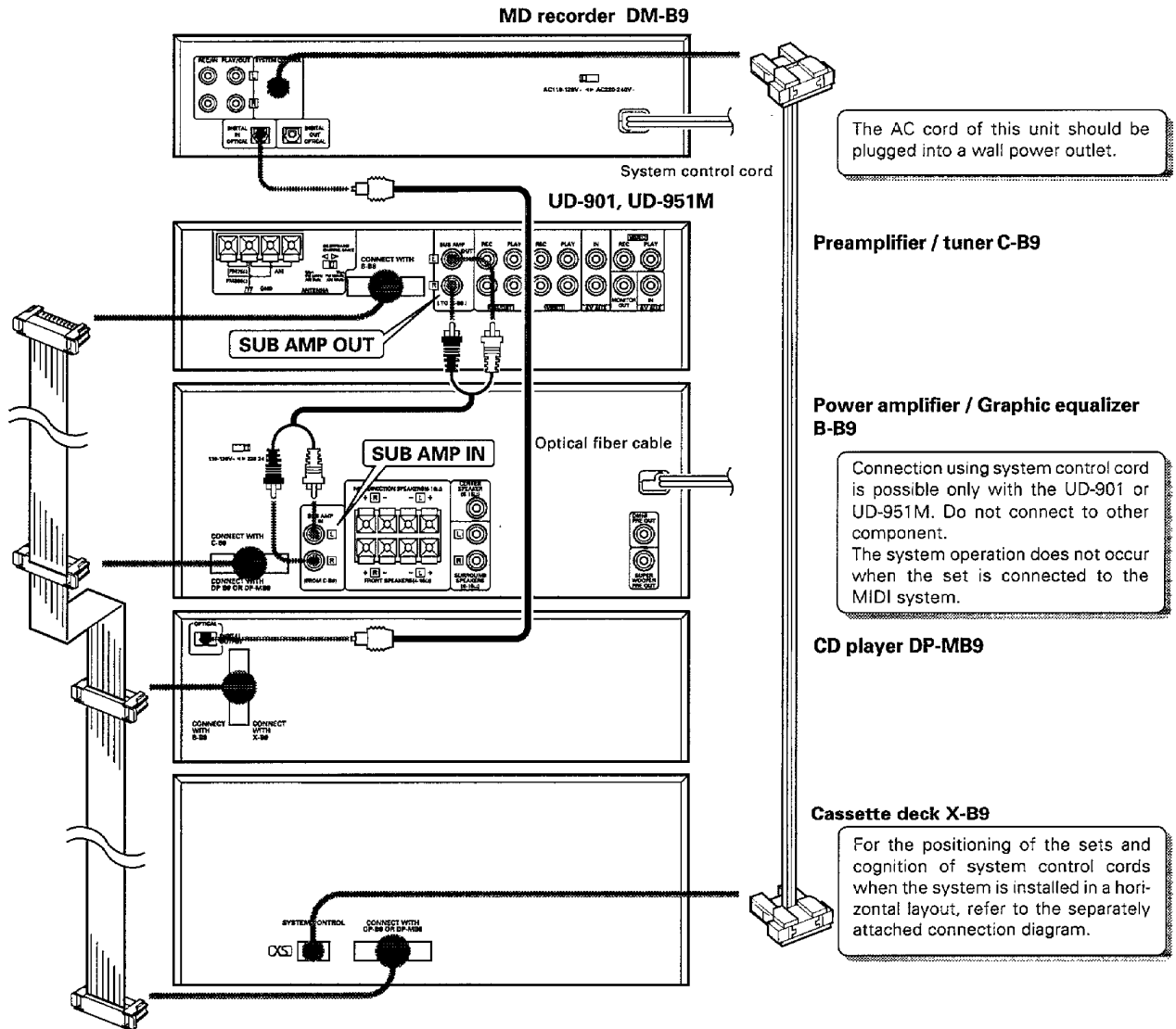

Connection of system control cord

Plugging the connector

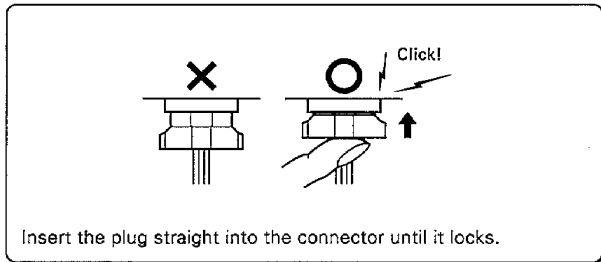

Unplugging the connector

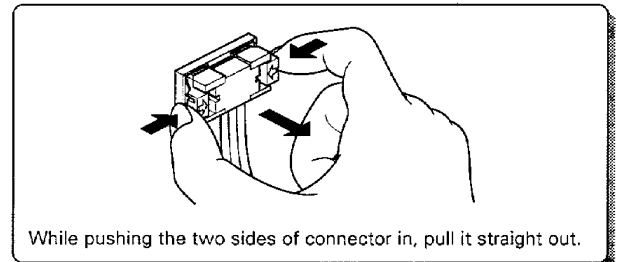

System operation

The basic operations can be controlled by using the remote control unit supplied with the system when UD-901, UD-951M is connected with the system control cords. Also, the easy operation function in which the system components act according to the input selection made on the amplifier is also available. Refer to the instruction manual supplied with the system for details.

Display

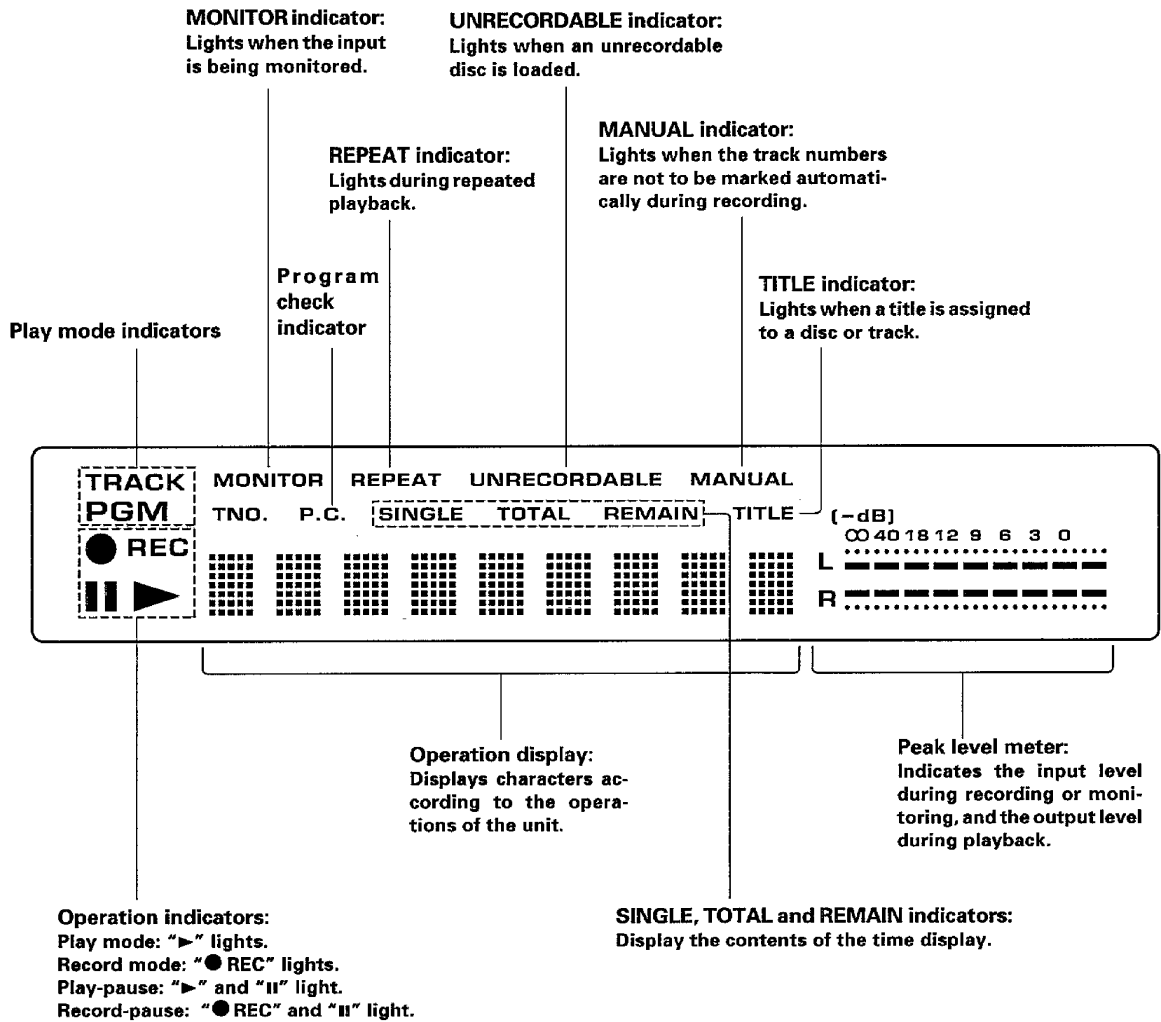

Listening through headphones

Plug the stereo headphones (with mini-plug) available in audio stores into the PHONES jack and adjust the listening volume with the PHONES LEVEL control on the front panel.

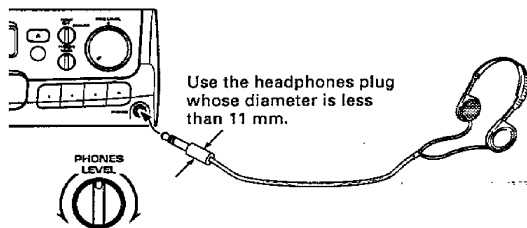

STAND BY mode of POWER switch

When the power cord is plugged into an AC outlet, "STANDBY" is displayed while the power is set to OFF. This is because, even when the power is set to OFF, a small amount of power is supplied to the system. This status is called the standby mode of the system. When "STANDBY" is displayed, the power can also be turned ON/OFF from the remote control unit.

Display

STANDBY

Remote control unit

▲ key
Press to open or close the disc tray.

POWER key
Press to turn the power ON and press again to activate the STAND BY mode.

Title operation keys (in blue letters) → P. 28
These keys are used as the title operation keys in the title entry mode.
DELETE key:
Deletes the character above the cursor. (Each press shifts the character position by one column toward the left.)
ENTER key:
Enters the title in memory.
▷ key:
Shift the cursor toward the right.
◁ key:
Shift the cursor toward the left.
◀▶ keys:
Changes the track number to which the title is assigned.
△, ▽ keys:
Selects an alphabet character, etc.

Operation keys
● **Record key:**
Press to start recording.
■ **Stop key:**
Press to stop recording or playback.
⏸ **Pause key:**
Press to pause recording or playback temporarily.
▶ **Play key:**
Press to start playback.
⏮ **Skip keys:**
Press to skip tracks.
⏪ **Search keys:**
Press to move the position being played in a track at a high speed in the forward or reverse direction.

Editing operation keys → P. 24
TRACK DELETE key:
Deletes a track.
TNO CANCEL key:
Cancels a track number.
TNO INSERT key:
Inserts a track number.

TITLE key
Press to activate the title entry mode.

Programming keys
PROGRAM key:
Enters the specified track number in the program.
CHECK key:
Checks the program contents.
CLEAR key:
Clears the program.

Numeric keys
In the TRACK or PROGRAM play mode, press to specify the desired track number.

P.MODE (Play mode) key
Press to activate the PROGRAM mode and press again to activate the TRACK mode.

MONITOR key → P. 19
Outputs the signal of the source selected with the input selector keys.

DISPLAY key → P. 19
Each press changes the display contents.

AUTO/MANUAL key → P. 21
Selects whether the track numbers are to be marked automatically during recording (AUTO) or to be marked manually after it (MANUAL).

REPEAT key
Press to activate repeated playback.

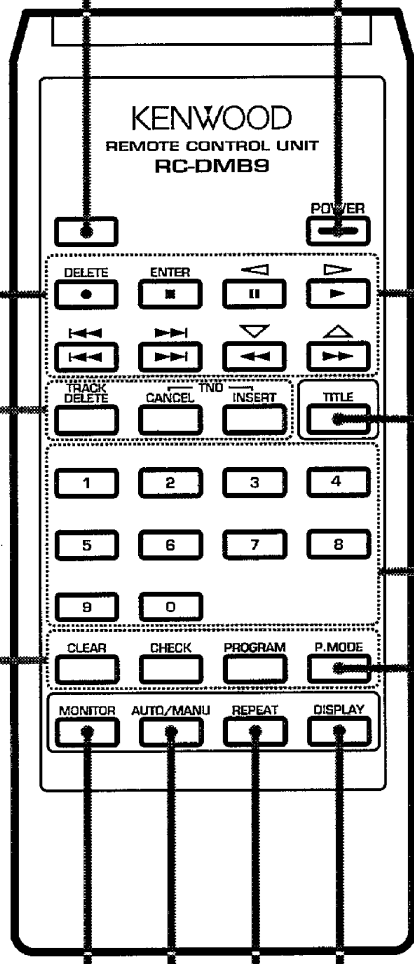

Model: RC-DMB9
Infrared ray system

Operation of remote control unit

Loading batteries

1 Remove the cover.

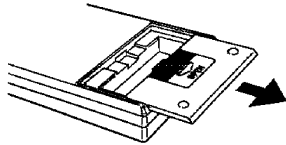

2 Insert batteries.

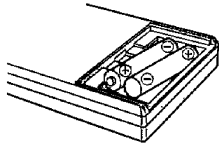

3 Close the cover.

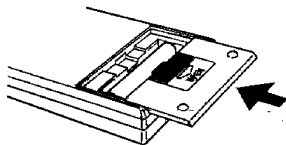

- Insert two R03 ("AAA"-size) batteries following the polarity indications.

Operation

After plugging the power cord into a power outlet, press the **POWER** key of the remote control unit to turn the power ON. When the power is turned ON, press the key of the function to be operated.

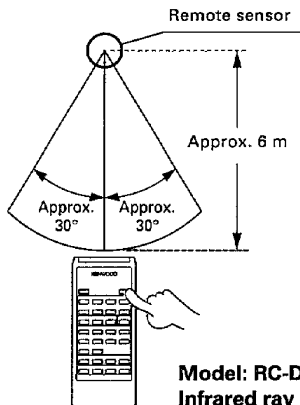

- When pressing more than one remote control keys successively, press the keys securely by leaving an interval of 1 second or more between keys.

Notes

1. The provided batteries are intended for use in operation checking, and their service life may be short.
2. When the remote controllable distance becomes short, replace both of the batteries with new ones.
3. If direct sunlight or the light of a high-frequency fluorescent lamp (inverter type, etc.) is incident to the remote sensor, malfunction may occur. In such a case, change the installation position to avoid malfunction.

Playback of Mini Disc

14

Use the following procedure to play a MD in the original order of tracks from track No. 1.

Before playing an MD

Set the **TIMER** switch to **OFF**.

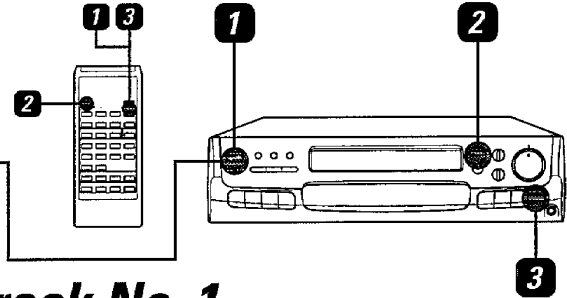
Playing tracks in order from track No. 1

1 Turn the power ON.

ON/STAND BY

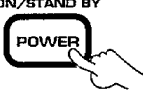

2 Load a Mini Disc.

① Open the tray.



② Place a Mini Disc.

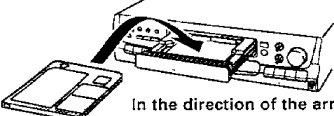

In the direction of the arrow.

③ Close the tray.



3 Start playback.



- "READING" blinks while the unit checks the contents of the disc.
- In case no disc is loaded:

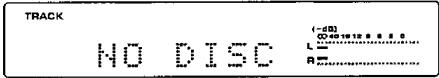

- Load only one disc at a time.
- If a title has been assigned to the disc, that title will be displayed.

After having displayed the last track number and the total playing time, the display changes to following.

Check that "TRACK" is lit.

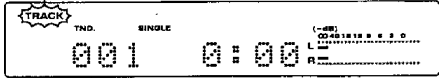

- If the TRACK indicator is not lit, press the **P.MODE** key of the remote control unit to light it.

- In a few seconds, playback starts from track No. 1.

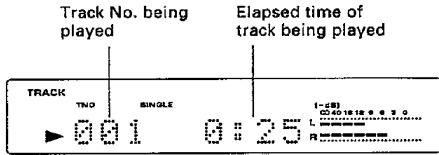

To stop playback

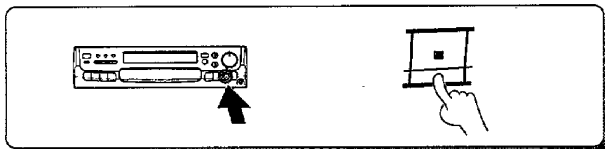

To pause playback

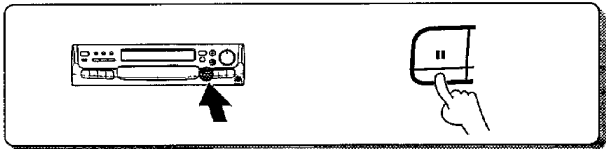

- Each press pauses and plays the MD alternately.

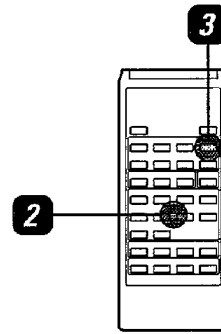

Playback from desired track

1 Check that the TRACK indicator is lit.

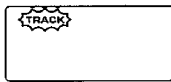

- If the TRACK indicator is not lit, press the **P.MODE** key of the remote control unit to light it.

2 Select the desired track number.

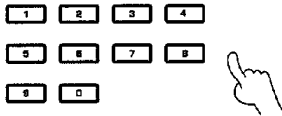

Press the numeric keys as shown below....

To enter track No. 23: Press **2** then **3**.

To enter track No. 40: Press **4** then **0**.

- If a track No. which does not exist on the disc is selected while the tray is open, the last track on the disc will be played.
- Once the tray has been closed or playback has started, a track No. which does not exist on the disc cannot be selected.

3 Start playback.



- Playback starts from the selected track and continues on the subsequent tracks.

Skipping tracks

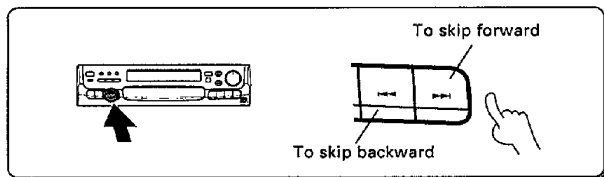

- The track in the direction of the pressed button is skipped, and the selected track will be played from the beginning.
- When the **⏮** key is pressed once during playback, the track being played will be played from the beginning. (If it is pressed within 2 seconds from the start of a track, the previous track to the current track will be played from the beginning.)

Searching in a track

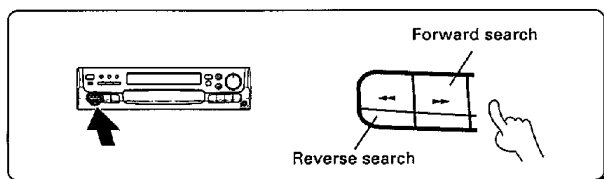

- Playback starts from the position where the key is released. (If the key was pressed in the pause mode, the unit returns to the pause mode at that position.)
- Sound is not output during forward or reverse search.
- When the forward search attains the next track, it will be played from the beginning.
- When the reverse search attains the beginning of the current track, it will be played from the beginning. (It is not possible to search other tracks than the current track being played.)
- Search is not possible if the current track is shorter than 5 seconds.

Use the following procedure to program desired tracks in a desired order. (up to 24 tracks)

Preparation



Be sure to enter the stop mode before proceeding to programming.

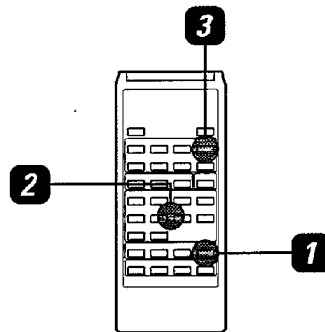

Programming tracks in a desired order

1 Activate the PROGRAM mode.

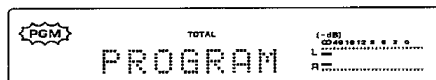
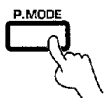

2 Select track numbers in the order you want to play them.

① Select the track number to be played.



②



To program more than one track, repeat steps ① and ② for each track.

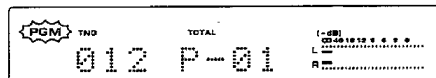

To program track No. 12:
Press ①, ② then **PROGRAM** key.

- Up to 24 tracks can be programmed. "PGM FULL" is displayed if you attempt to program a 25th track. More than 24 tracks cannot be selected.
- If you made a mistake, press the **CLEAR** key and enter the track No. again.
- A track shorter than 5 seconds cannot be programmed.

3 Start playback.



- Tracks will be played in the order they are programmed.
- When the **◀◀** or **▶▶** key is pressed during playback, tracks will be skipped in the direction of the pressed button.

To stop playback

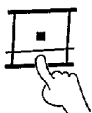
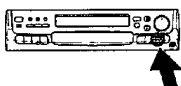

Preparation

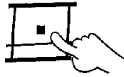

Be sure to enter the stop mode before adding, changing or clearing tracks in the program.

To add a track to the program

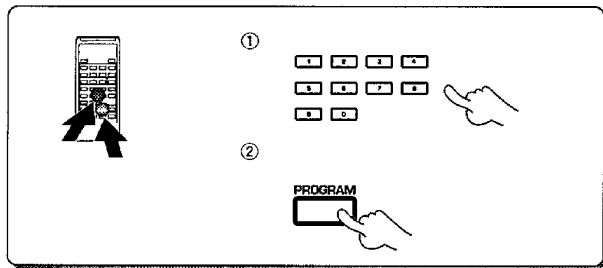

- When a track No. is entered, the track will be added to the end of the existing program.

To change a track in the program

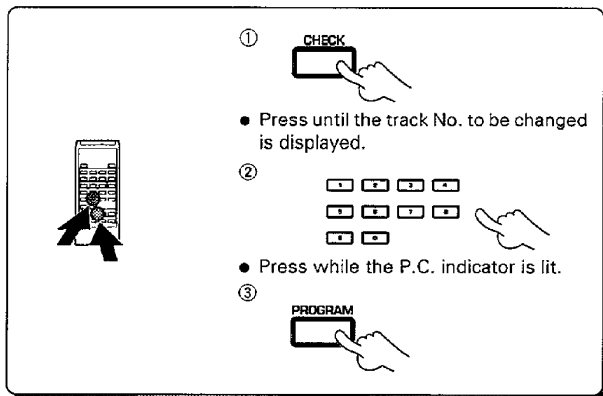

- Press until the track No. to be changed is displayed.

- Press while the P.C. indicator is lit.

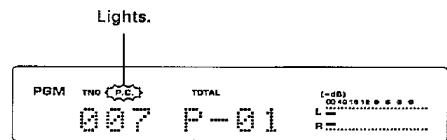

To clear tracks from the program

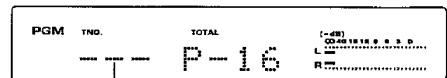
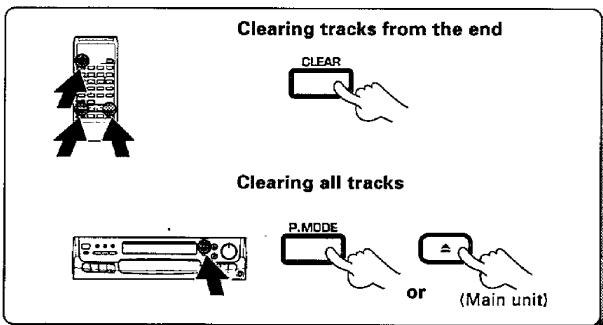

Cleared status

- Each time the key is pressed, the last track in the program is cleared.

- The entire program is cleared.

Repeated playback

To repeat only the programmed tracks

① Program the tracks to be repeated.

① P.MODE

● Press in stop mode.

② 1 2 3 4

5 6 7 8

9 0

③ PROGRAM

● Repeat steps ② and ③.

② Switch REPEAT ON.

③ Start playback.

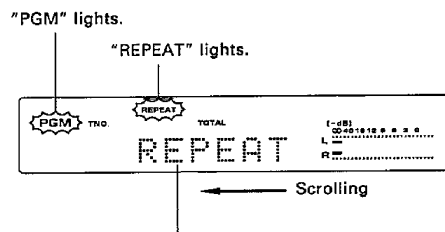

"REPEAT ON" is displayed when the REPEAT key is pressed to ON.
"REPEAT OFF" is displayed when the REPEAT key is pressed to OFF.

- All of the programmed tracks will be repeated.
- In case only one track is programmed, only that track will be repeated.

To stop repeated playback

Press the REPEAT key again.

- The REPEAT indicator goes off and the playback following the current mode (PROGRAM) of the MD player starts.

To repeat the entire disc

① Activate the TRACK mode.

① P.MODE

● Press in stop mode.

② Switch REPEAT ON.

③ Start playback.

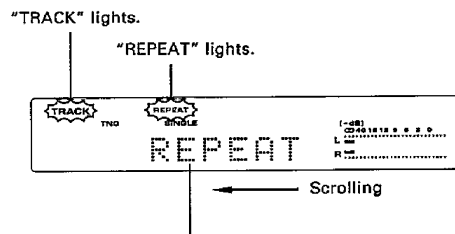

"REPEAT ON" is displayed when the REPEAT key is pressed to ON.
"REPEAT OFF" is displayed when the REPEAT key is pressed to OFF.

To stop repeated playback

Press the REPEAT key again.

- The REPEAT indicator goes off and the playback following the current mode (TRACK) of the MD player starts.

DISPLAY key

The display contents varies every time the DISPLAY key is pressed.



- ① **SINGLE +:**
Time elapsed since the beginning of the track being played.
- ② **SINGLE -:**
Time remaining in the track being played.
- ③ **TOTAL:**
In TRACK mode: Total playing time of the tracks in the disc.
In PROGRAM mode: Total playing time of the programmed tracks.
- ④ **REMAIN:**
Remaining recordable time of the disc.
- ⑤ **TITLE:**
Title, in case a title has been assigned to it.

In TRACK mode

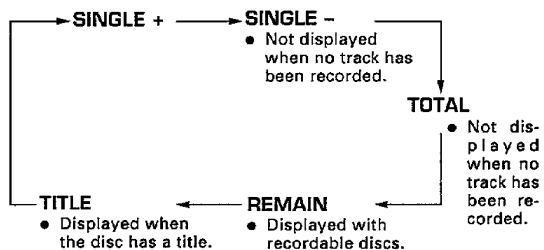

SINGLE - display example

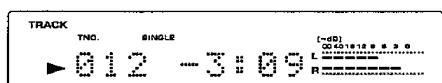

In PROGRAM mode

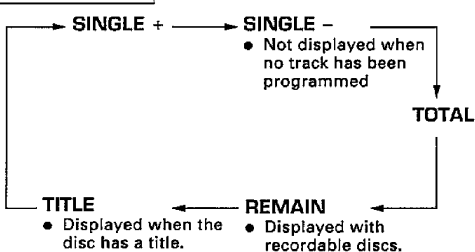

MONITOR key

Press the MONITOR key in stop mode to output the input source selected with the INPUT switch at the output jacks (both ANALOG and DIGITAL).

- MONITOR is OFF when the DELETE key is pressed.



Each time the key is pressed, the monitor output signal is switched on or off.

"MONITOR ON" is displayed when the MONITOR key is pressed to ON.
"MONITOR OFF" is displayed when the MONITOR key is pressed to OFF.

Lights when MONITOR is ON.

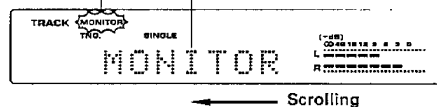

Recording (analog input)

20

The input jacks to which the audio cords accept analog signals. This unit records the analog signals input to the REC IN jacks by converting them into digital signal. (This recording of analog inputs is simply referred to as analog recording.)

Preparation

Load a recordable Mini Disc.



- ① Open the tray
- ② Load a disc.
- ③ Close the tray.

1 Check the recordable time of the disc. (Set the display mode to REMAIN.)

DISPLAY



Press repeatedly.

2 Select the ANALOG input.

INPUT
OPT. ANALOG



3 Select AUTO or MANUAL.

AUTO/MANU



Remote control unit

4 Adjust the recording level.

- ① Enter the record-pause mode.
Press the [RECORD] key then the [PAUSE] key.
- ② Play the source to be recorded.
- ③ Adjust the recording level.

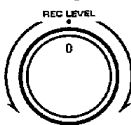

5 Press the Record key.



6 After recording, take out the disc.

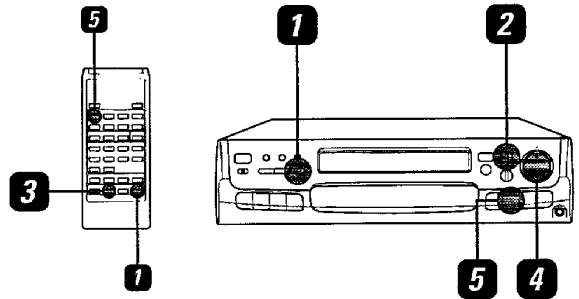

"REMAIN" lights.

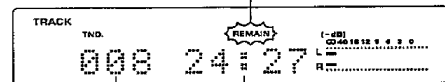

Last track No.

Remaining recordable time

- "BLANK" is displayed if no track has been recorded on the disc. ("NO TRACKS" is displayed if the disc has a title.)
- The total time of the recorded section will be displayed first.
- If the recordable time is short, refer to "Deleting a track". → P.26

Not lit in AUTO mode, lit in MANUAL mode.

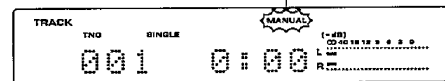

- AUTO:** If a no-sound input has lasted for 2 seconds, the track number will be incremented automatically by "1". Use this mode when recording all of the tracks in a CD.
- MANUAL:** Set to MANUAL when you want to change the track number manually. → P.21
Use this mode when recording tracks from several CDs including single CDs.

Adjust so that 0 dB segments light only occasionally.

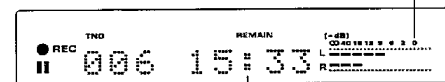

Remaining recordable time on disc

- Decrease the level if the red segments of the peak level meter light.

Recording is not possible if the following characters are displayed.

"PROTECT": Indicates that the disc is protected against write.
Change the position of the write protect tab. → P.34

- Every time the PAUSE key ([II]) is pressed, the track number is incremented by "1".

This unit writes various information in disc when it is taken out of the unit. Therefore, when the [STOP] key is pressed after completion of editing or recording, "WRITING" blinks for a while before the disc comes out.

- Do not apply vibrations to the unit during "WRITING".

To stop recording

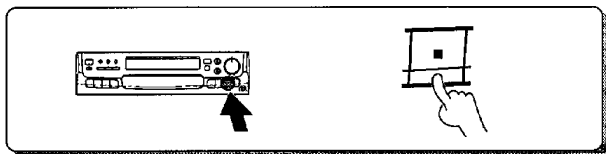

To pause recording

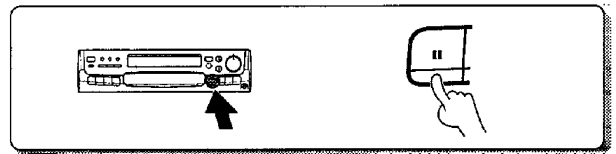

- Press the key again to resume recording. At this time, the track number is incremented by "1".

AUTO/MANUAL key

This key is used to select whether track numbers are to be marked automatically during recording or they are to be marked manually during or after recording. The track numbers can be used to locate the beginning of a track during playback or program tracks.

AUTO

If a no-sound input has lasted for 2 seconds during recording, the track number will be incremented automatically by "1". Usually, use this position for recording. Use this mode when recording all of the tracks in a CD. When recording music containing a continuous section with a very low level, for example when recording classic music, the track number may be incremented by "1" after such a section. In this case, cancel the track number later. (p. 25) It is recommended to use the MANUAL mode when recording such a kind of music.

MANUAL

The signal is recorded without marking any number. The track numbers can be marked to the desired positions by pressing the **TNO INSERT** key (p. 24) during or after recording. This position is convenient when recording live sound or classic music containing long which pianissimo sections onto disc.

Use this mode when recording tracks from several CDs including single CDs.

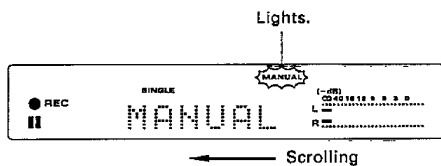

- AUTO: "MARKING AUTO" is displayed.
- MANUAL: "MARKING MANUAL" is displayed.

Recording (digital input)

22

This unit can record digital signals on recordable Mini Discs. When this unit is connected with a CD player through an optical fiber cable, the digital signal input to the DIGITAL IN (OPTICAL) jacks can be recorded in the form of digital signal. (This recording of digital input is simply referred to as digital recording.)

Preparation

Load a recordable Mini Disc.



- ① Open the tray.
- ② Load a disc.
- ③ Close the tray.

1 Check the recordable time of the disc. (Set the display mode to REMAIN.)



Press repeatedly.

2 Select the OPT input.



3 Select AUTO or MANUAL.



Remote control unit

4 Press the Record key.



5 Play the CD player.

- Start playback after having confirmed that the display show "0:00". Otherwise, the beginning of the track may not be recorded.

6 After recording, take out the disc.

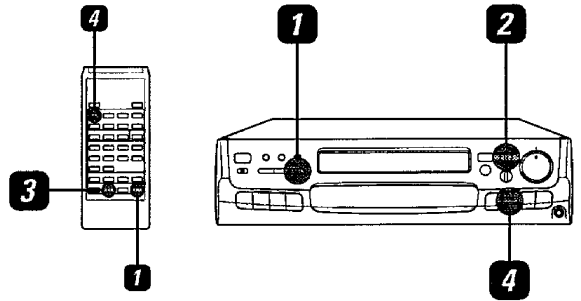

"REMAIN" lights.

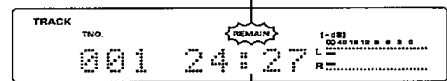

Remaining recordable time

- "BLANK" is displayed if no track has been recorded on the disc. ("NO TRACKS" is displayed if the disc has a title.)
- The total time of the recorded section will be displayed first.
- If the recordable time is short, refer to "Deleting a track". → P.28

Not lit in AUTO mode, lit in MANUAL mode.

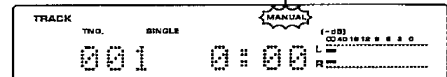

- AUTO:** If a no-sound input has lasted for 2 seconds, the track number will be incremented automatically by "1". Use this mode when recording all of the tracks in a CD.
- MANUAL:** Set to MANUAL when you want to change the track number manually. → P.21
Use this mode when recording tracks from several CDs including single CDs.

Recording is not possible if the following characters are displayed.

- ① "PROTECT": Indicates that the disc is protected against write.
→ Change the position of the write protect tab. → P.34
- ② "UNLOCK": The sampling frequency is not 44.1 kHz.
→ Use analog recording. → P.23
- ③ "PROHIBIT": Digital recording is prohibited by SCMS.
→ Use analog recording. → P.23

- Every time the PAUSE key (II) is pressed, the track number is incremented by "1".

This unit writes various information in disc when it is taken out of the unit. Therefore, when the key is pressed after completion of editing or recording, "WRITING" blinks for a while before the disc comes out.

- Do not apply vibrations to the unit during "WRITING".

To stop recording

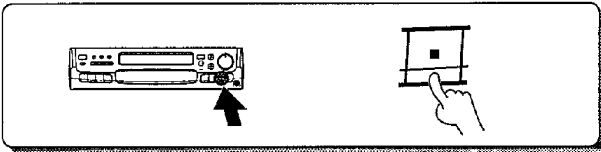

To pause recording

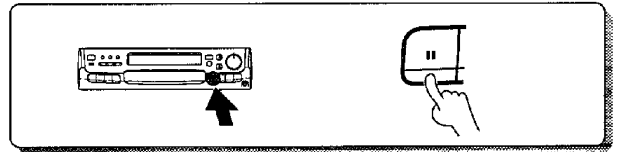

- Press the key again to resume recording. At this time, the track number is incremented by "1".

Digital recording and SCMS

The Mini Disc cannot record digital input signals from all sources. Note that digital recording is not possible with the following two cases.

- ① *In case the source uses other sampling frequency than 44.1 kHz. — "UNLOCK" is displayed and recording stops.
- ② In case the source contains the copy prohibit code (SCMS – Serial Copy Management System).
 - "PROHIBIT" is displayed and the unit enters the record-pause mode. Recording starts if the copy prohibition is cleared within 15 minutes, but recording is aborted if it is not.

*Sampling frequency

The sampling frequency refers to the frequency used to split analog waveform when it is converted into digital signal. The DBS tuner and some DAT decks use a sampling frequency of 32 kHz or 48 kHz, while the CD player and some DAT decks use a sampling frequency of 44.1 kHz. Therefore, the Mini Disc recorder can record digital signals from CD players and some DAT decks, but cannot record digital signals from DBS tuners. Before attempting digital recording from a DAT deck, be sure to check that it uses a sampling frequency of 44.1 kHz.

SCMS (Serial Copy Management System)

Designed for copyright protection, the SCMS is a prescription that copying of digital signals as they are in the digital form between digital audio equipment is allowable only for one generation.

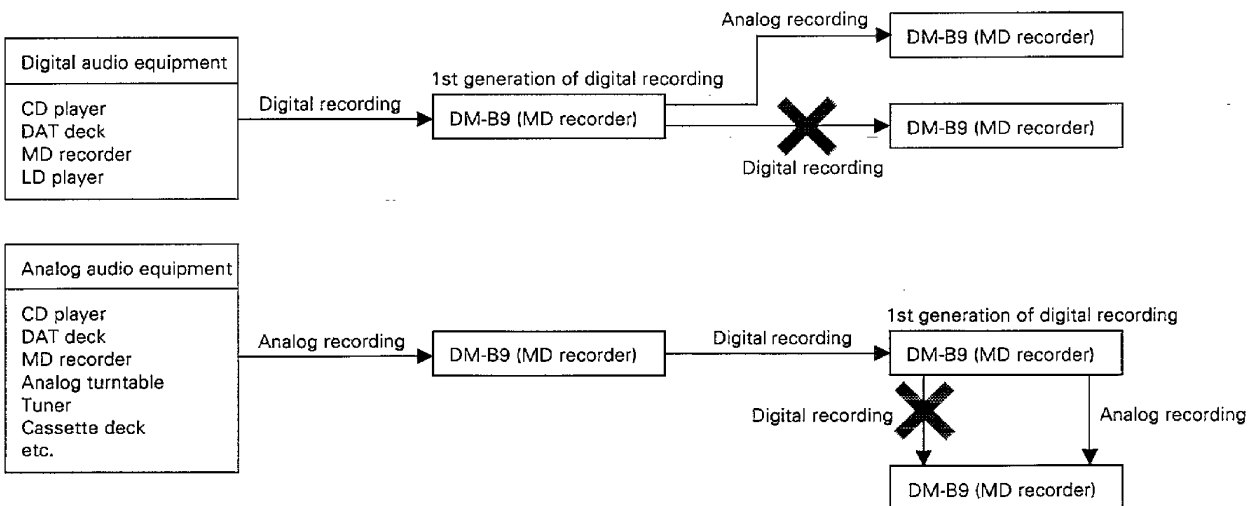

With a recorded Mini Disc, the editing features allow to insert track numbers to the desired points, cancel unnecessary track numbers and delete tracks.

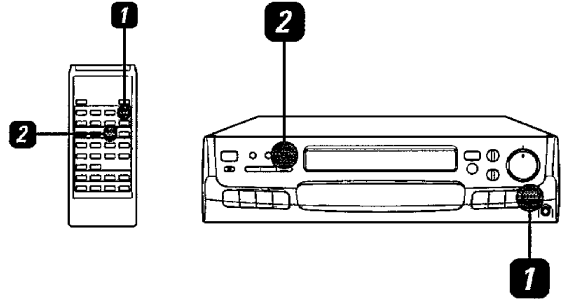

Inserting track numbers

1 Play (Record) music.

2 Press the TNO INSERT key at the desired position.

- The unit will enter the pause mode if a track number is inserted during playback. To resume playback, press the ► key.

Add other track numbers to the desired positions by repeating the procedure above. (Up to 255 track numbers)

This unit writes various information in disc when it is taken out of the unit. Therefore, when the key is pressed after completion of editing or recording, "WRITING" blinks for a while before the disc comes out.

- Do not apply vibrations to the unit during "WRITING".

Track numbers can be marked to the desired positions. The track numbers located after the newly inserted number are automatically incremented by "1". If you insert track numbers to the positions you particularly like to listen to, it will be easy to skip to these positions during playback.

- To insert track numbers during recording, set the AUTO/MANUAL mode to MANUAL.
- This is also possible in pause mode.

- "INSERT!!" is displayed first, then the track number is inserted.
- Due to the restriction of the MD standard, track numbers may be unable to be inserted in some cases. In such a case, "CAN'T DO" is displayed.

Disc status when a track number is inserted:

Before insertion:

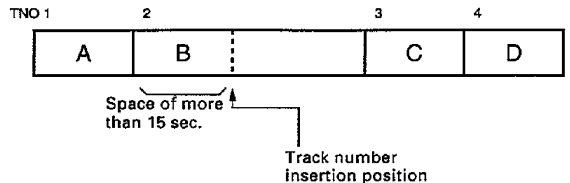

Track number insertion by pressing TNO INSERT key

After insertion:

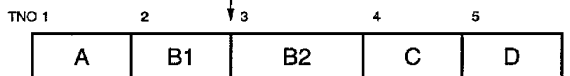

Music B is divided into two tracks, to which track Nos. 2 and 3 will be assigned. The track numbers of music C and D will be incremented respectively by "1".

If track number is inserted during playback, the unit searches this position and enters pause mode. (If it is during recording, the recording continues.)

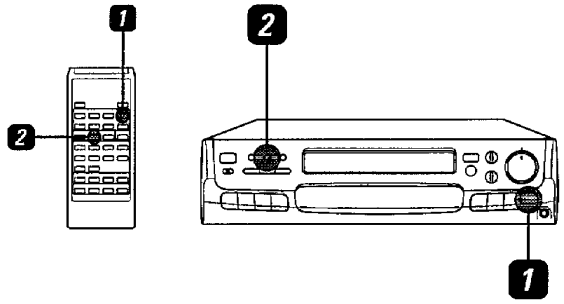

Canceling track numbers

Two tracks can be connected and unified into a single track or unnecessary track numbers can be removed with the following procedure. The track numbers located after the canceled number are automatically decremented by "1". The blank section between the selections remains the same. Use the following procedure to make several tracks be played continuously as one track or to unify the recording which has been recorded in several tracks during recording.

1 Play music.

2 Press the TNO CANCEL key at the desired position.

- The unit will enter the pause mode. To resume playback, press the ► key.

• This is also possible in pause mode.

- Track No. 1 cannot be canceled. ("CAN'T DO" will be displayed.)
- "CANCEL!" is displayed first, then the track number is canceled.
- The track numbers may sometimes not be able to be canceled due to restriction imposed by the MD standard. In such a case, "CAN'T DO" is displayed.

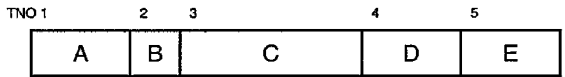

Less than 10 sec.

Such a track number sometimes cannot be canceled.

Unification of two tracks into one:

Before unification of music B and C:

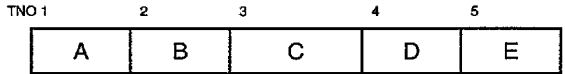

Connection point

Cancel track number by pressing the TNO CANCEL key.

After connection of music B and C:

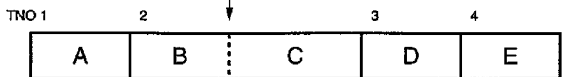

Music B and C form a single track, to which track No. 2 will be assigned. The track numbers of music D and E will be decremented respectively by "1".

The unit searches this position and enters pause mode.

This unit writes various information in disc when it is taken out of the unit. Therefore, when the ▲ key is pressed after completion of editing or recording, "WRITING" blinks for a while before the disc comes out.

- Do not apply vibrations to the unit during "WRITING".

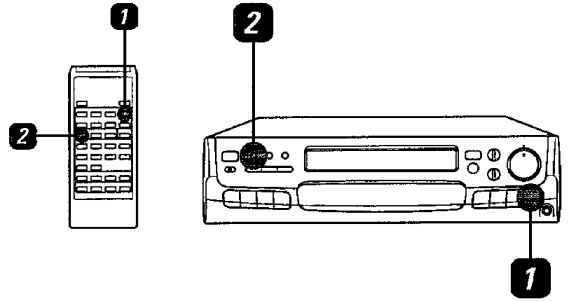

Deleting a track

The following procedure allows to delete one entire track from a recorded disc. The track numbers located after the deleted track are automatically decremented by "1". Be careful in using this function because the track cannot be recovered once it has been deleted.

1 Play the track to be deleted.



2 Press the **TRACK DELETE** key.



- The unit will enter the pause mode.

"DEL . OK?" will be displayed.

To abort the deletion, press:

- ▶ key: The unit resumes playback.
- ⏸ key: The unit enters pause mode.

If the track can really be deleted, press the **TRACK DELETE** key again.

- "DELETE!!" is displayed first, then the track is deleted.

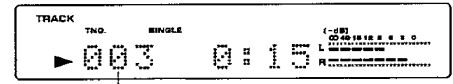

- This is also possible in pause mode at the position where the track number of the track to be deleted is marked.

Before deletion of music C:

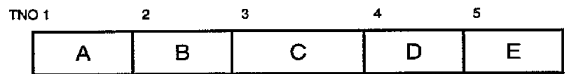

↑ Play the track to be deleted.

Delete the track by pressing the **TRACK DELETE** key.

After deletion of music C:

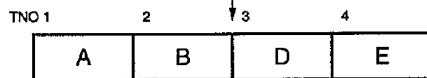

Music C will be deleted and the track numbers of music D and E will be decremented respectively by "1".

- When deleting more than one track, it is recommended to delete the track with the largest track number first for, if the track with the smaller number is deleted first, the intermediate track numbers would be altered.

Deleting all tracks

①



②



Press the TRACK DELETE key in stop mode.

"ALL DEL. ?" is displayed.

To abort deletion, press the **■** key.

If all of the tracks can really be deleted, press the **TRACK DELETE** key again.
"DELETE!!" → "BLANK"

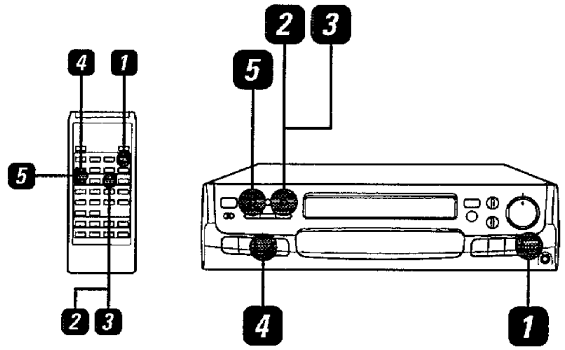

Deleting a part of a track

This function is convenient for, for example, deleting a part of a long space to shorten it.

Select the part to be deleted.

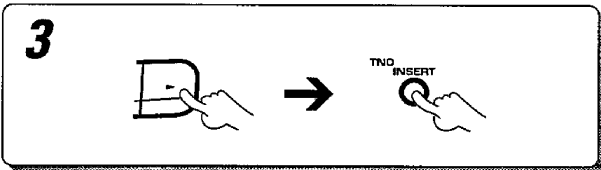
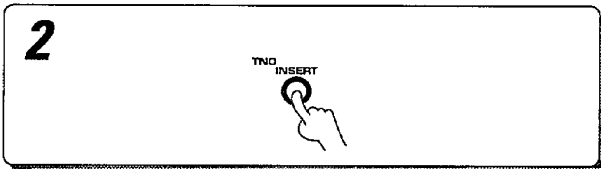
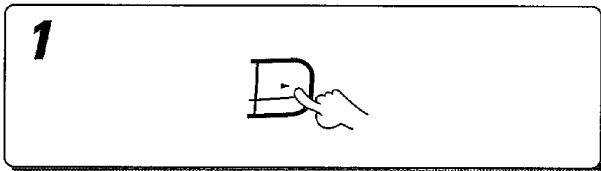

Operation for deleting a part of track:

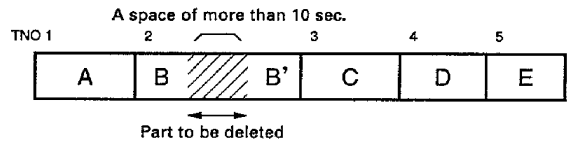

Marking a track number to the part to be deleted

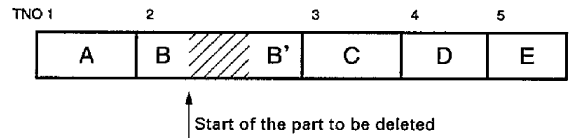

Insert a track number by pressing the **TNO INSERT** key.
 • This is also possible in pause mode.

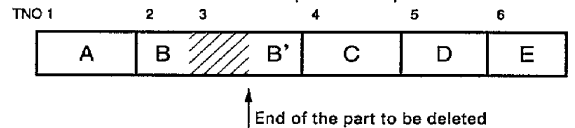

Insert another track number by pressing the **TNO INSERT** key.
 • This is also possible in pause mode.

Delete the newly added track.

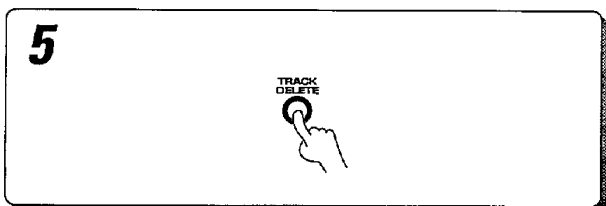
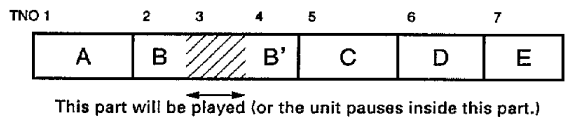
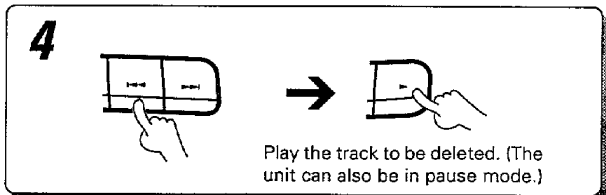

Delete the track by pressing the **TRACK DELETE** key.

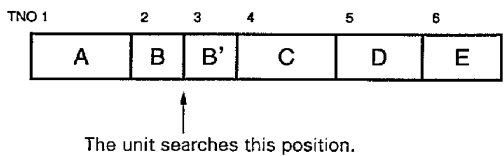

title assignment

28

This unit allows to assign titles to a recorded disc or tracks recorded in it. The titles makes it possible to identify the tracks being played.

Preparation

① Enter the stop mode.

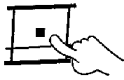

②

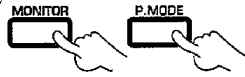

- Turn the MONITOR off and set to TRACK mode.

Assigning a title to disc

1 Press the **TITLE** key.

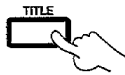

- Perform the preparation procedure above.

2 Press the **ENTER** key.



3 Input a title.

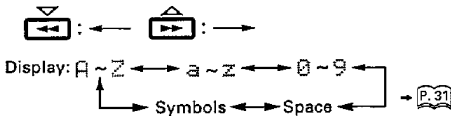

4 Shift the character position.



Up to 140 characters can be input by repeating steps 3 and 4 above. (A total of 1792 characters can be input for disc and track titles.)

5 Enter the title in memory.

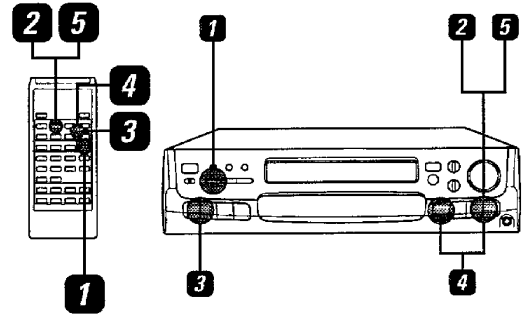

Make sure that "MONITOR" is not displayed.

Lights.

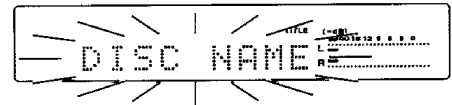
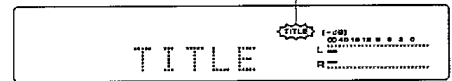

Blinks.

- To abort operation, press the **TITLE** key again.



- If you made a mistake, press the **(DELETE)** key and select the correct character.
- Every time the **DISPLAY** key is pressed, the start characters can be changed to uppercase alphabet, lowercase alphabet and numerals.

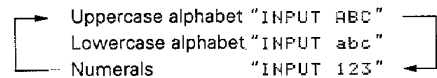

- To change a character:
 - ① Let blink the character to be changed.
 - ② Change it to the desired character. → P.30

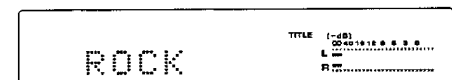

Scrolling

- The unit enters the mode for "Assigning a title to track". → P.29
- If it is required to assign a title to the disc only, press the **TITLE** key.

This unit writes various information in disc when it is taken out of the unit. Therefore, when the **▲** key is pressed after completion of editing or recording, "WRITING" blinks for a while before the disc comes out.

- Do not apply vibrations to the unit during "WRITING".

Preparation

① Enter the stop mode.

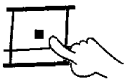

②

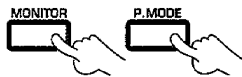

- Turn the MONITOR off and set to TRACK mode.

Assigning a title to track

1 Press the **TITLE** key.



- Perform the preparation procedure above.

2 Select the track to be titled.

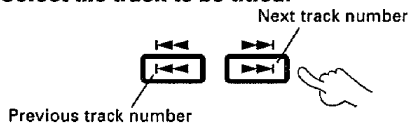

3 Press the **ENTER** key.



4 Input a title.

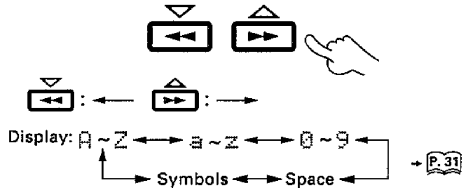

5 Shift the character position.



Up to 140 characters can be input by repeating steps 4 and 5 above. (A total of 1792 characters can be input for disc and track titles.)

6 Enter the title in memory.

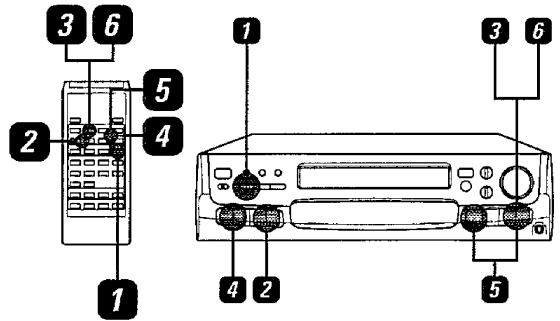

Make sure that "MONITOR" is not displayed. Lights.

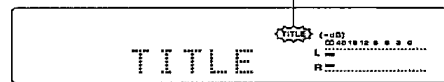

Display the track number of the track to be titled.



- If you made a mistake, press the **●** (DELETE) key and select the correct character.
- Every time the **DISPLAY** key is pressed, the start characters can be changed to uppercase alphabet, lowercase alphabet and numerals.

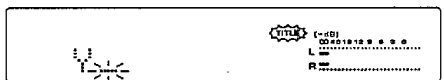
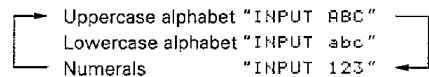

- To change a character:
 - Let blink the character to be changed. → P.30
 - Change it to the desired character.

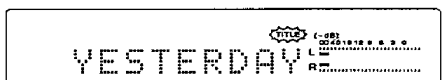

← Scrolling

- The unit enters the mode for assigning the title to the next track.
- To end title assignment, press the **TITLE** key.

Preparation

① Enter the stop mode.



②

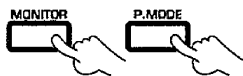

- Turn the MONITOR off and set to TRACK mode.

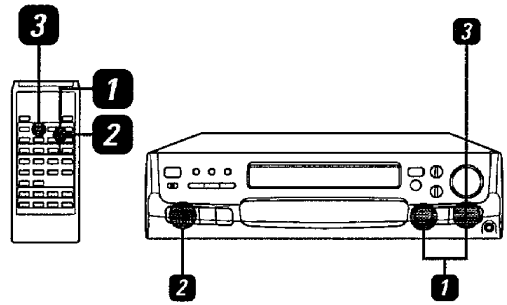

Changing a title (Perform the preparation procedure above)

To change a disc title:

Perform the procedure for "Assigning a title to a disc" until before step 4. → P.28

To change a track title:

Perform the procedure for "Assigning a title to track" until before step 5. → P.29

1 Let blink the character to be changed.



2 Input a character.

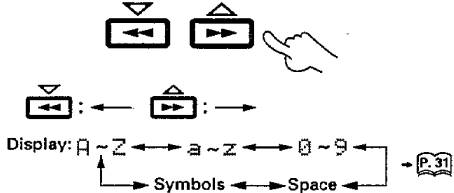

To change more than one character, repeat steps 1 and 2 above.

3 Enter in memory.



This unit writes various information in disc when it is taken out of the unit. Therefore, when the ▲ key is pressed after completion of editing or recording, "WRITING" blinks for a while before the disc comes out.

- Do not apply vibrations to the unit during "WRITING".

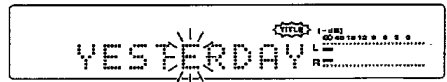

- Every time the DISPLAY key is pressed, the start characters can be changed to uppercase alphabet, lowercase alphabet and numerals.

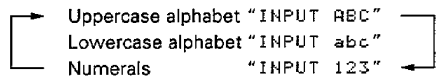

← Scrolling

- To end title change, press the TITLE key.

Preparation

① Enter the stop mode.



②



- Turn the MONITOR off and set to TRACK mode.

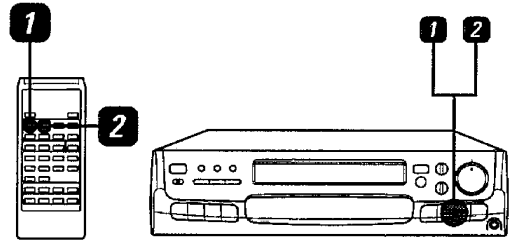

Deleting a title (Perform the preparation procedure above)

To delete a disc title:

Perform the procedure for "Assigning a title to a disc" until before step 2. → [P. 28](#)

To delete a track title:

Perform the procedure for "Assigning a title to track" until before step 3. → [P. 29](#)

1 Press the DELETE key.



Press repeatedly.



- Every time the **DELETE** key is pressed, the characters scroll by one column toward the left.

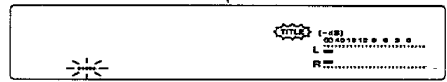

- Press repeatedly until the display becomes as shown above.

2 Enter in memory.



- "DEL.TITLE" is displayed, then the title is deleted.
- Press the **TITLE** key to end deletion.

This unit writes various information in disc when it is taken out of the unit. Therefore, when the **▲** key is pressed after completion of editing or recording, "WRITING" blinks for a while before the disc comes out.
 • Do not apply vibrations to the unit during "WRITING".

Characters that can be displayed

This unit can display the following characters and symbols.

Uppercase alphabet : ABCDEFGHIJKLMNOPQRSTUVWXYZ

Lowercase alphabet : abcdefghijklmnopqrstuvwxyz

Numerals : 0123456789

Symbols : ! " # \$ % & ' () * + , - . / : ; < = > ? @ [\] ^ _ ` { | } ~ ()

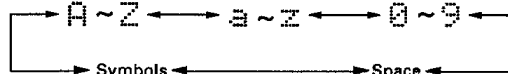

Characters change in this order.

Timer operations

32

By connecting this unit to the UD-901, UD-951M system through a system control cord, playback and recording can be activated at the desired time of day.

System Connection → P. 9

Playback or recording can also be activated at the desired time by using a commercially available timer.

System Connection → P. 33

Preparation for timer playback or recording

Connect the power cords of the associated components so that their power can be turned ON through the audio timer. Also, be sure to read carefully the instruction manual of the timer.

Timer playback

1 Turn the powers of the associated components ON.

2 Load a Mini Disc.

3 Set the amplifier volume.

- ① Play the Mini Disc and output sound. → P. 14
- ② Adjust the amplifier volume.
- ③ Stop the disc.

4 Set the timer ON time.

Set the timer so that it supplies power at the specified time.

5 Set the **TIMER** switch to **PLAY**.



6 Turn the power of this unit OFF.

ON/STAND BY

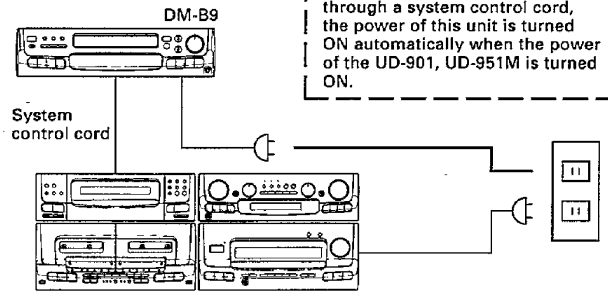

- Read carefully the instruction manuals of the system. (Read carefully the instruction manuals of the timer.)

- When the set time comes, the disc playback starts automatically.

Memory backup

When the power cord is unplugged from the power outlet, the memory will be held for about 3 days. Be sure to remove the disc after recording.

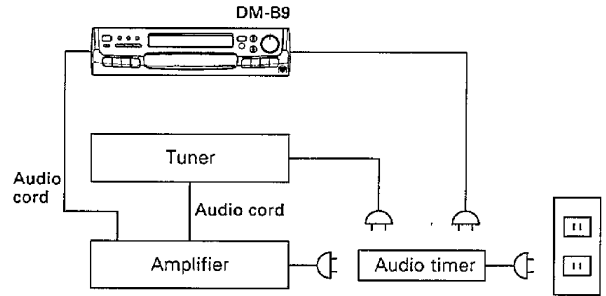

Timer recording of radio

1 Turn the powers of the associated components ON.

2 Receive the desired radio station.

3 Make preparations for recording.

- ① Load a recordable Mini Disc.
 - Be sure to check the remaining recordable time. → 
- ② Adjust the recording level.

4 Minimize the amplifier volume.

5 Set the timer ON time.

Set the timer so that the tuner reception can be started at the desired ON time of the day.

6 Set the **TIMER** switch to **REC**.



7 Turn the power of this unit OFF.

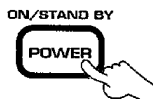

- Adjust so that the 0 dB segments of the peak level meter light only occasionally.

- Read carefully the instruction manuals of the system. (Read carefully the instruction manuals of the timer.)

- When the set time comes, recording starts automatically.

Installation position

The MD recorder is very sensitive to vibrations. It should be installed in a position subject to as small vibration as possible.

Dust countermeasure

The shutter of the disc cartridge is permanently open while the disc is loaded in the set. Therefore, to prevent dust from penetrating inside the disc, take the disc out of the unit immediately after completion of recording or playback.

Handling of Mini Disc

As the Mini Disc is accommodated inside a cartridge, it can be handled without caring about dust or fingerprint. However, stained or soiled cartridge may cause malfunction. To enjoy beautiful sound for extended period of time, take care on the following points.

Do not touch the disc directly.

Do not touch the disc by opening the shutter with your hand. The cartridge will be damaged if it is forced open.

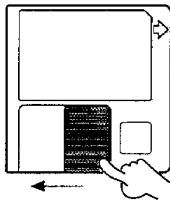

Storage position

Do not leave Mini Discs in place where the temperature and/or humidity are extremely high (for example, in a place subject to direct sunlight).

Care

Wipe dust and dirt attached on the cartridge periodically with a dry cloth.

Write protect tab

To protect recorded contents against accidental erasure, set the write protect tab of the disc open. Return the tab to the original position when you want to record signals on the disc.

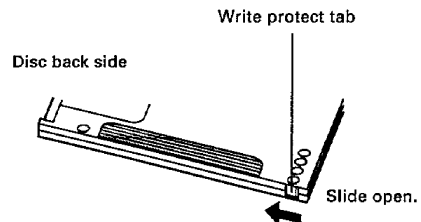

Beware of condensation

When water vapor comes into contact with the surface of cold material, water drops are produced.

If condensation occurs, correct operation may not be possible, or the unit may not function correctly.

This is not a malfunction, however, and the unit should be dried. (To do this, turn the POWER switch ON and leave the unit as it is for several hours.)

Be especially careful in the following conditions:

- When the unit is brought from a cold place to a warm place, and there is a large temperature difference.
- When a heater starts operating.
- When the unit is brought from an air-conditioned place to a place of high temperature with high humidity.
- When there is a large difference between the internal temperature of the unit and the ambient temperature, or in conditions where condensation occurs easily.

The Mini Disc system has the features as summarized in the following.

- ① Like CD (Compact Disc), playback can be started from any position. (Random access)
- ② It uses a disc with a diameter of 64 mm that is accommodated in a cartridge.
- ③ Two types of discs can be used.
- ④ Up to 74 minutes of recording or playback is possible using high-efficiency coding technology.
- ⑤ Countermeasure against vibration is taken using semiconductor memory chip.

Two Mini Disc types

There are two types of Mini Disc, the one designed exclusively for playback and the other which is both recordable and playable.

Playback-only Mini Disc

This type of MD can be used only for playback, and is used by the commercially-available music MD software packages. The playback-only MD is an optical disc like the Compact Disc (CD). The signals are recorded as the presence or absence of small pits and read out by an optical, non-contact pickup.

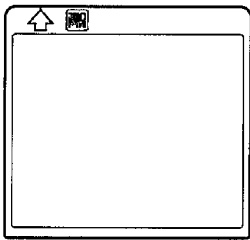

Recordable Mini Disc

This MD is a magneto-optical disc which can be recorded by magnetic field modulation. To record signals, laser light is irradiated from the bottom side of the magneto-optical disc and magnetic field is applied from the upper side of it.

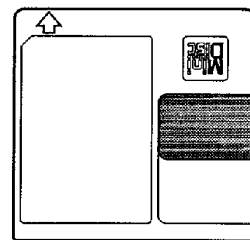

High-efficiency coding technology "ATRAC"

The Mini Disc has only a half the size of the Compact Disc but provides the same recording time. This is made possible by ATRAC*, a newly developed high-efficiency coding technology.

* ATRAC: Adaptive TRansform Acoustic Coding

The ATRAC compresses the music data to about 1/5 the amount of data which would be obtained with conventional technology, by cutting off the sound components which do not pose problem in audition even when they are not present. This has made it possible to record or play up to 74 minutes.

Example 1:

Sound does not affect the sensitivity of ears

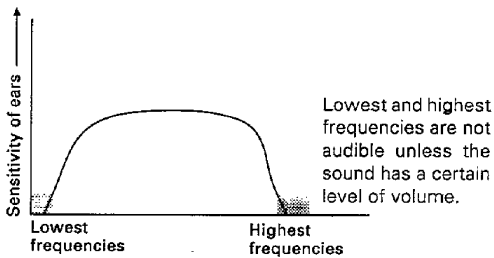

Sound-skip prevention memory

During playback, this unit always stores signals in memory temporarily to prevent sound from being skipped in case of vibration. As a result, even when the data from the optical pickup is interrupted due to vibration, etc., the music will not be interrupted because the memory holds the data for several seconds.

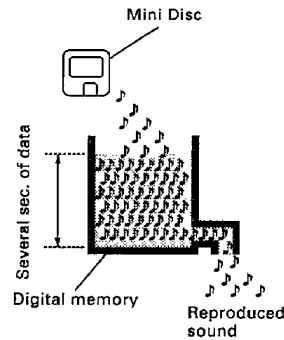

During normal playback

The sound data for several seconds is always stored during playback.

Example 2:

Small sound near large sound

A small sound is not audible to human ears if it is produced at the same time as a large sound. (Masking effect)

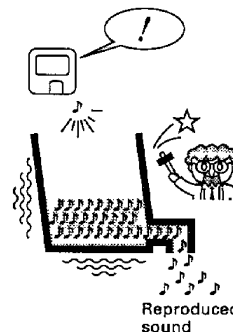
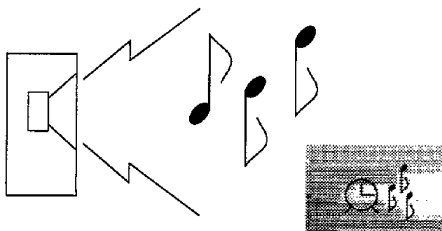

In case of vibration

When the readout from disc is interrupted momentarily due to vibration or shock, the reproduced sound from the memory will not be interrupted.

n case of difficulty

Displayed messages and actions to be taken against them

Displayed Message	Meaning	Action
NO DISC	<ul style="list-style-type: none"> ● No disc is placed on the tray. 	<ul style="list-style-type: none"> ● Load a disc.
PROTECT	<ul style="list-style-type: none"> ● An attempt is made to record on a write-protected disc. 	<ul style="list-style-type: none"> ● Change the position of the write protect tab to the write position. → P. 34 ● Use a recordable MD.
UNLOCK	<ul style="list-style-type: none"> ● An attempt is made to record digital signal from a source using other sampling frequency than 44.1 kHz. ● The optical fiber cable is not connected. (The connector is unplugged.) 	<ul style="list-style-type: none"> ● Use analog recording. ● Connect the optical fiber cable.
PROHIBIT	<ul style="list-style-type: none"> ● An attempt is made to record digital signal from a source while its digital copy has been prohibited by SCMS. 	<ul style="list-style-type: none"> ● Use analog recording.
DISC FULL	<ul style="list-style-type: none"> ● There is no recordable area on the disc. ● An attempt is made to record a 256th track. ● During title assignment, an attempt is made to input a 1793rd character in a disc. 	<ul style="list-style-type: none"> ● Use another recordable disc. ● More than 255 tracks cannot be recorded per disc. ● More than 1792 characters cannot be input per disc.
MAX. TITLE	<ul style="list-style-type: none"> ● An attempt is made to input a 141st character on a track title. 	<ul style="list-style-type: none"> ● More than 140 characters cannot be input per track.
PGM FULL	<ul style="list-style-type: none"> ● An attempt is made to program a 25th track. 	<ul style="list-style-type: none"> ● More than 24 tracks cannot be programmed.
BLANK	<ul style="list-style-type: none"> ● The disc does not contain any recorded. 	<ul style="list-style-type: none"> ● When playback is required, use a recorded disc.
NO TRACKS	<ul style="list-style-type: none"> ● The disc does not contain any tracks but has a disc title. 	<ul style="list-style-type: none"> ● The disc can be used for recording without any problem.
READING	<ul style="list-style-type: none"> ● The TOC data of the disc is being read. 	<ul style="list-style-type: none"> ● This is a normal operation.
WRITING	<ul style="list-style-type: none"> ● The data related to editing or recording is being written in the disc. 	<ul style="list-style-type: none"> ● This is a normal operation.
DISC ERR.	<ul style="list-style-type: none"> ● The contents of UTOC are abnormal. 	<ul style="list-style-type: none"> ● Use another disc or perform "ALL DELETE" operation. → P. 26
CAN'T DO	<ul style="list-style-type: none"> ● An attempt is made to delete a track which is too short. ● An attempt is made to delete track No. 1. 	<ul style="list-style-type: none"> ● A shorter track than the specified length cannot be deleted. ● Track No. 1 cannot be deleted.
EDIT OK?	<ul style="list-style-type: none"> ● An information that a track "should not be deleted" has been programmed. 	<ul style="list-style-type: none"> ● If it is required to delete the track regardless of the programmed information, press the TRACK DELETE key. → P. 28
NOT AUDIO	<ul style="list-style-type: none"> ● A disc other than the specified disc is loaded. 	<ul style="list-style-type: none"> ● Use a proper disc.
CAN'T PGM	<ul style="list-style-type: none"> ● An attempt is made to program a too short track. 	<ul style="list-style-type: none"> ● Tracks with less than 5 seconds cannot be programmed.
NO TITLE	<ul style="list-style-type: none"> ● The disc title has not been entered. 	<ul style="list-style-type: none"> ● Assign a title to the disc. → P. 28 ● Some of the playback-only discs do not have titles.
NO BACKUP	<ul style="list-style-type: none"> ● The stored data in the disc was destroyed by a certain reason when the power cord was unplugged without removing the disc after editing or recording. 	<ul style="list-style-type: none"> ● Press the ▲ key and take out the disc. At this time, the entire data which has been stored in the disc will be lost.

Symptoms related to MD standard

Symptom	Cause
"DISC FULL" is displayed while the disc still has a remaining recordable time.	<ul style="list-style-type: none"> More than 255 tracks (track No. 256 or more) cannot be recorded. (There may be also cases in which recording is impossible while the track number is less than 256.) In such a case, the REMAIN time display shows "--:--".
Insertion or cancellation of a track number is not possible.	<ul style="list-style-type: none"> These operations are sometimes impossible on some positions in a disc.
When an attempt is made to insert a track number during recording, the track number blinks after the insertion operation.	<ul style="list-style-type: none"> Insertion during recording is not possible within 4 seconds after an insertion.
The time display stops momentarily during fast forward or reverse operation.	<ul style="list-style-type: none"> There is a case in which the time display stops, through this happens very rarely.

Other symptoms

Symptom	Cause	Remedy
Sound is not output even when the play key is pressed.	<ul style="list-style-type: none"> The cords are connected erroneously. No disc has been loaded. A non-recorded disc has been loaded. 	<ul style="list-style-type: none"> Connect the cords in accordance with "System connections". Load a disc. Load a prerecorded disc or playback-only disc.
Recording is not possible	<ul style="list-style-type: none"> The disc is write-protected. An attempt is made to record digital signal from a source while its digital copy has been prohibited by SCMS. The recording level is too low (in case of analog recording). A playback-only disc has been loaded. The disc does not have a recordable area. 	<ul style="list-style-type: none"> Change the position of the write protect tab to the write position or use a recordable disc. Use analog recording. Adjust the recording level again. Use a recordable disc. Use another disc.
Sound is distorted.	<ul style="list-style-type: none"> The recording level has not been adjusted. A disc in which distorted sound has been recorded is played. 	<ul style="list-style-type: none"> Read "Recording". Use another disc.
Noise is noticeable.	<ul style="list-style-type: none"> An external noise is induced. 	<ul style="list-style-type: none"> Install the unit at a position apart from an electric appliance or TV set.

Memory backup

When the power cord is unplugged from the power outlet, the memory will be held for about 3 days. Be sure to remove the disc after recording.

Notes

- This system is microprocessor-controlled, so malfunction may occur due to external noise or interference noise. In such a case, unplug the power cord, plug it and turn power on again.
- Do not use contact cleaners because it could cause a malfunction. Be specially careful against contact cleaners containing oil, for they may deform the plastic components.

Specifications

System	Mini disc digital audio system
Laser	Semiconductor laser
Recording method	Field modulation overwrite method
Sampling frequency	44.1 kHz
Playing rotation	Approx. 400 rpm ~ 900 rpm (CLV)
Audio compression	ATRAC (Adaptive Transform Acoustic Coding)
Output level / impedance	1.2 V / 3.3 kΩ
Digital output	
Optical	- 15 dBm ~ - 21 dBm
	(Wave length 660 nm)
Headphone output	6.0 mW (16 Ω)
Input sensitivity / impedance	300 mV / 22 kΩ or more

General

Power consumption	35 W
Dimensions	W: 270 mm (10 - 5 / 8")
	H: 70 mm (2 - 3 / 4")
	D: 322 mm (12 - 11 / 16")
Weight (Net)	4.4 kg (9.7 lb)

Note:

KENWOOD follows a policy of continuous advancements in development. For this reason specifications may be changed without notice.

Strömbrytarens POWER beredskapsläge

Indikatorn STAND BY tänds efter nätkabelns anslutning till ett vägguttag, oavsett strömbrytarens POWER till/frånslag. Detta anger att en liten mängd ström leds till komponenten som stöd för minnesinnehållet. Detta läge kallas för beredskapsläget. Strömbrytarens på fjärrkontrollen kan användas för att slå på och av strömmen så länge indikatorn STAND BY lyser.

Virtanäppäimrens (POWER) valmiustilan (STAND BY)

Kun laitteen verkkajohto on liitetty pistorasiaan, valmiustilan merkkivalo syttyy riippumatta virtanäppäimrens (POWER) asennosta (ON / OFF). Merkkivalo osoittaa, että laitteessa on hieman virtaa muistin sisältöjen ylläpitoa varten. Tätä tilaa kutsutaan valmiustilaksi. Kun valmiustilan merkkivalo (STAND BY) palaa, laitteen virta voidaan kytkeä ja katkaista kaukosäätimellä.

Afbrydertastens (POWER) STAND BY funktion

Når apparatets strømledning er tilsluttet en stikkontakt, lyser STAND BY indikatoren, uanset om der er tændt ved afbryderen på apparatet eller ej. Det angiver, at apparatet bliver forsynet med en ganske lille mængde strøm til opret-holdelse af hukommelsens indhold.

Denne funktion kaldes STAND BY. Når STAND BY indikatoren er tændt, kan strømmen til apparatet slås til og fra med fjernsty-ringsenheden.

PÅ/AV-knappens Stand-by funksjon

Når strømledningen til dette anlegget er satt i en vekselstrømskontakt, vil STAND-BY indikatorlampen lyse enten PÅ/AV-knappen er på-eller avslått. Dette betyr at en viss mengde strøm tilføres anlegget slik at innholdet i minnet ikke går tapt.

Denne funksjonen kalles Stand-by. Når indikatorlampen for STAND-BY er tent, kan strømmen slås PÅ / AV fra fjernkontrollen.

**For CANADA
DOC REGULATION**

"This digital apparatus does not exceed the CLASS B limits for radio noise emissions from digital apparatus as set out in the radio interference regulations of the Canadian Department of Communications."

**For the U.S.A.
FCC WARNING**

This equipment may generate or use radio frequency energy. Changes or modifications to this equipment may cause harmful interference unless the modifications are expressly approved in the instruction manual. The user could lose the authority to operate this equipment if an unauthorized change or modification is made.

NOTE:

This equipment has been tested and found to comply with the limits for a Class B digital device, pursuant to Part 15 of the FCC Rules. These limits are designed to provide reasonable protection against harmful interference in a residential installation. This equipment may cause harmful interference to radio communications, if it is not installed and used in accordance with the instructions. However, there is no guarantee that interference will not occur in a particular installation. If this equipment does cause harmful interference to radio or television reception, which can be determined by turning the equipment off and on, the user is encouraged to try to correct the interference by one or more of the following measures:

- Reorient or relocate the receiving antenna.
- Increase the separation between the equipment and receiver.
- Connect the equipment into an outlet on a circuit different from that to which the receiver is connected.
- Consult the dealer or an experienced radio/TV technician for help.

KENWOOD